

1 2 3 4 5 6 7 8

REVISIONS			
ISS	ZONE	DESCRIPTION	PER REQUEST \ DATE

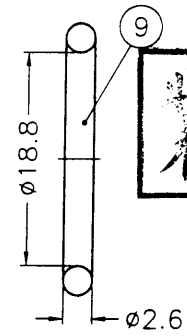

業務部

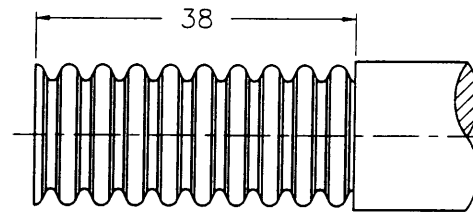
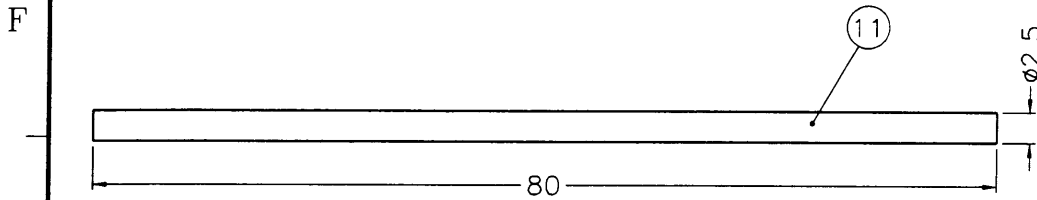
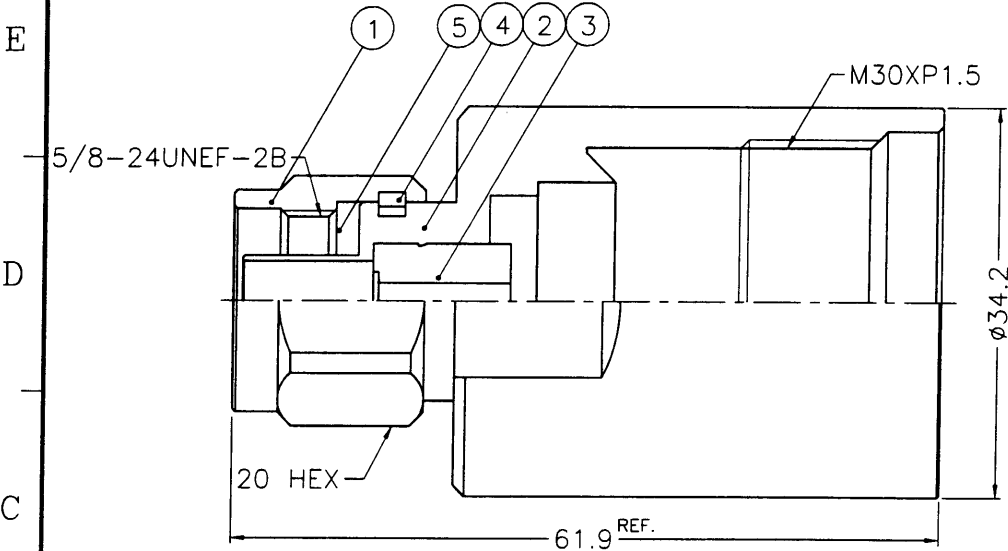

RECOMMENDED CABLE STRIPPING DIM'S

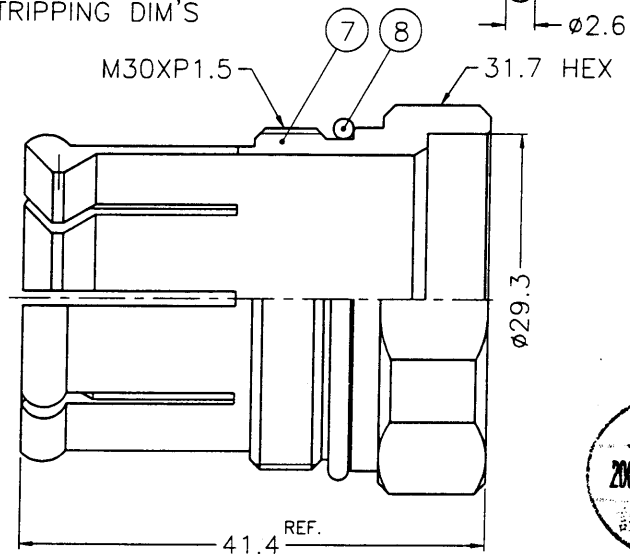

出圖
2000.10.16
設計部

- NOTES: FINISH (PLATING THICKNESS IN MICRO-INCHES)
1. BRASS PER QQ-B-626
 2. ALBALOY PLATING (COPPER-TIN-ZINC)
 3. SILVER PL. 200 MIN. THICK OVER COPPER STRIKE
 4. TEFLON MIL-P-19468
 5. NICKEL PL. 100 MIN. THICK OVER COPPER STRIKE
 6. SILICONE GREASE PER POLYTEX 55-M OR EQUIVALENT

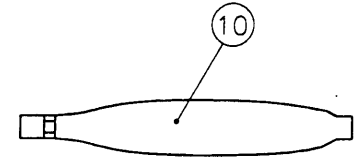
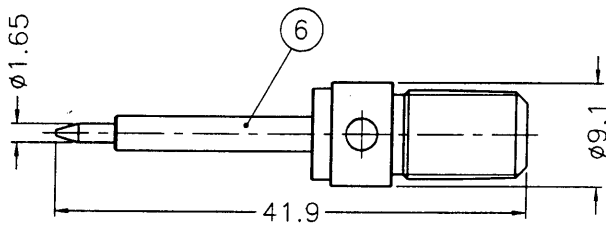

NO.	DESCRIPTION	MATERIAL	FINISH	Q'TY	DRAWING NO.
11	TOOL BAR	S45C	NOTE 5	1	N87070303-11
10	LUBRICATOR	NOTE 6	NOTE 6	1	N87070302-11
9	GASKET	SILICONE	RED	1	GS-24/188XD26
8	GASKET	SILICONE	RED	1	GS-304/27XD17
7	NUT	NOTE 1	NOTE 2	1	N87070303-7
6	CONTACT PIN	NOTE 1	NOTE 3	1	N87070303-6
5	GASKET	SILICONE	RED	1	GS-156/8X15
4	RETAINER RING	SUS 304	NATURAL	1	N5000-7-C
3	INSULATOR	NOTE 4	NATURAL	1	N87070303-3
2	BODY	NOTE 1	NOTE 2	1	N87070303-2
1	SHELL	NOTE 1	NOTE 2	1	N5000-1H

DIMENSIONS ARE IN MILLIMETERS
UNLESS OTHERWISE SPECIFIED TOLERANCES
0.5-6 = ±0.2
6-30 = ±0.4
30-120 = ±0.6
120-315 = ±1
315-1000 = ±1.6
1000-2000 = ±2.4

PART NO.	
APPROVED	DATE 10-12-00'
CHECKED	DATE 10-12-00'
DRAWN	DATE 10-12-00'

Amphenol - Kai Jack	
TAINAN TAIWAN	
TITLE	N PLUG (FOR ANDREW 7/8" LDF5-50A HELIAX CABLE)
DRAWING NO.	KJ-N1141G1-N/NTS-7/8A-50
FILE NO.	F:\DWG\N\1141G1\78A\NNTS

A

1 2 3 4 5 6 7 8

820-2210758